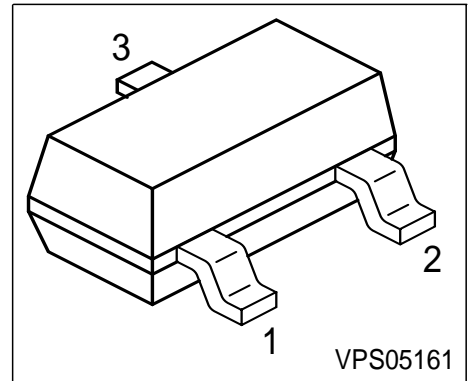
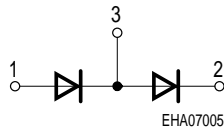
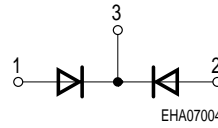
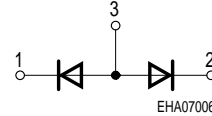

Silicon Schottky Diodes

- General-purpose diode for high-speed switching
- Circuit protection
- Voltage clamping
- High-level detecting and mixing

BAS70

BAS70-04

BAS70-05

BAS70-06

| Type | Marking | Pin Configuration | | | Package |
|----------|---------|-------------------|--------|-----------|---------|
| BAS70 | 73s | 1 = A | 2 n.c. | 3 = C | SOT23 |
| BAS70-04 | 74s | 1 = A1 | 2 = C2 | 3 = C1/A2 | SOT23 |
| BAS70-05 | 75s | 1 = A1 | 2 = A2 | 3 = C1/C2 | SOT23 |
| BAS70-06 | 76s | 1 = C1 | 2 = C2 | 3 = A1/A2 | SOT23 |

Maximum Ratings

| Parameter | Symbol | Value | Unit |
|--|-----------|-------------|------------------|
| Diode reverse voltage | V_R | 70 | V |
| Forward current | I_F | 70 | mA |
| Surge forward current, $t \leq 10\text{ms}$ | I_{FSM} | 100 | |
| Total power dissipation | P_{tot} | | mW |
| $T_S \leq 72^\circ\text{C}$, BAS70 | | 250 | |
| $T_S \leq 48^\circ\text{C}$, BAS70-04; BAS70-06 | | 250 | |
| $T_S \leq 22^\circ\text{C}$, BAS70-05 | | 250 | |
| Junction temperature | T_j | 150 | $^\circ\text{C}$ |
| Operating temperature range | T_{op} | -55 ... 150 | |
| Storage temperature | T_{stg} | -55 ... 150 | |

Thermal Resistance

| Parameter | Symbol | Value | Unit |
|--|------------|------------|------|
| Junction - soldering point ¹⁾ | R_{thJS} | | K/W |
| BAS70 | | ≤ 310 | |
| BAS70-04; BAS70-06 | | ≤ 410 | |
| BAS70-05 | | ≤ 510 | |

¹⁾For calculation of R_{thJA} please refer to Application Note Thermal Resistance

Electrical Characteristics at $T_A = 25^\circ\text{C}$, unless otherwise specified

| Parameter | Symbol | Values | | | Unit |
|---|-------------|--------|-------------------|--------------------|---------------|
| | | min. | typ. | max. | |
| DC Characteristics | | | | | |
| Breakdown voltage $I_{(BR)} = 10 \mu\text{A}$ | $V_{(BR)}$ | 70 | - | - | V |
| Reverse current $V_R = 50 \text{ V}$ | I_R | - | - | 0.1 | μA |
| Forward voltage $I_F = 1 \text{ mA}$ $I_F = 10 \text{ mA}$ $I_F = 15 \text{ mA}$ | V_F | - | 375 705 880 | 410 750 1000 | mV |
| AC Characteristics | | | | | |
| Diode capacitance- $V_R = 0 \text{ V}, f = 1 \text{ MHz}$ | C_T | - | 1.6 | 2 | pF |
| Differential forward resistance $I_F = 10 \text{ mA}, f = 10 \text{ kHz}$ | r_f | - | 30 | - | Ω |
| Charge carrier life time $I_F = 25 \text{ mA}$ | τ_{rr} | - | - | 100 | ps |

Diode capacitance $C_T = f(V_R)$

$f = 1\text{MHz}$

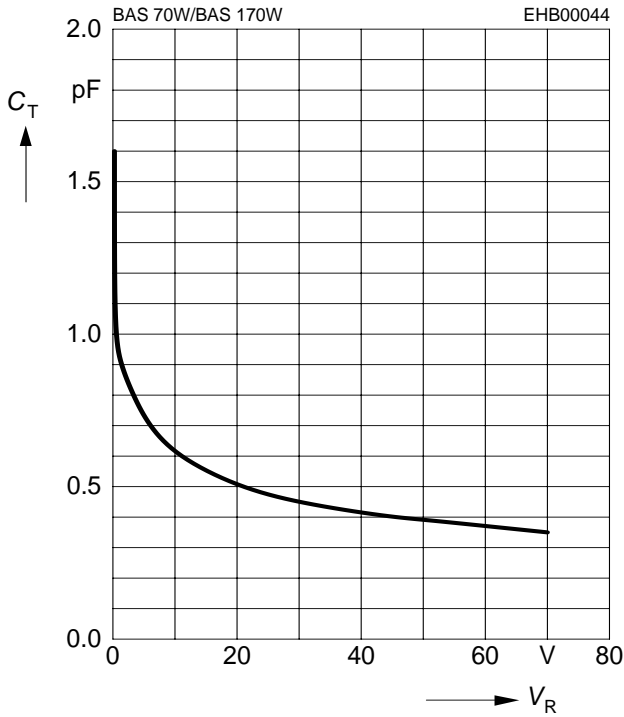

Differential forward resistance $r_f = f(I_F)$

$f = 1\text{MHz}$

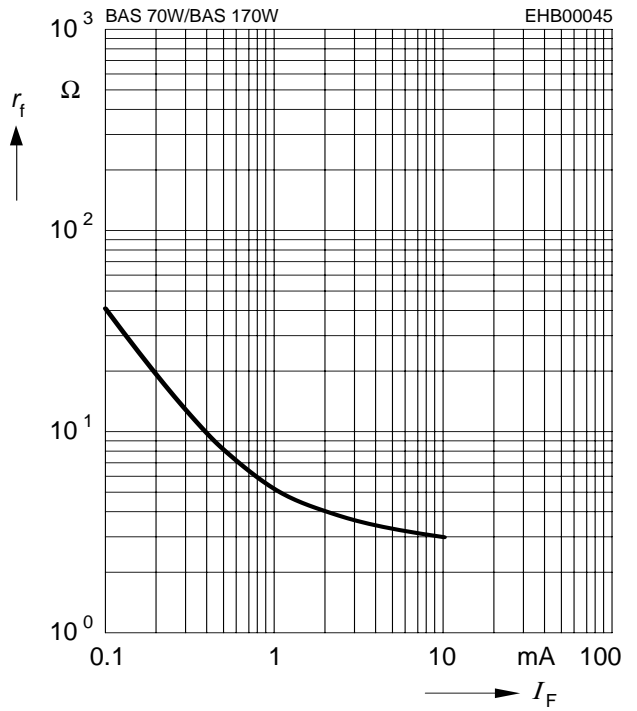

Reverse current $I_R = f(V_R)$

$T_A = \text{Parameter}$

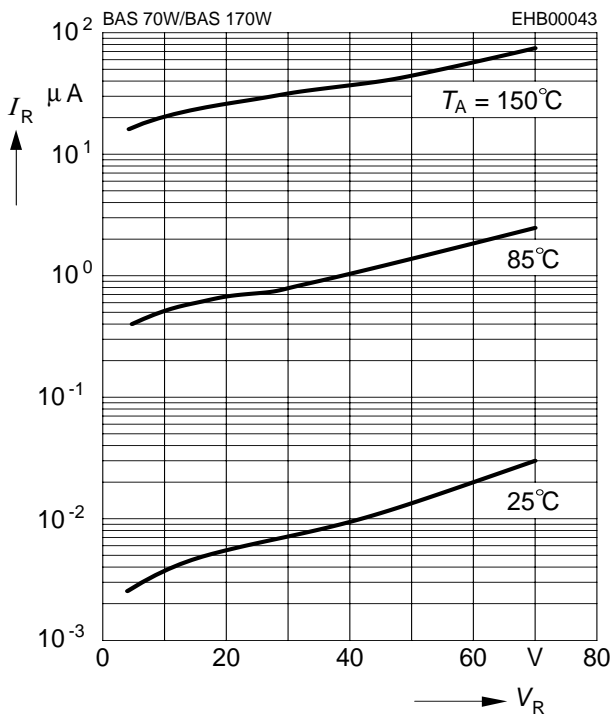

Forward current $I_F = f(T_S)$

BAS70

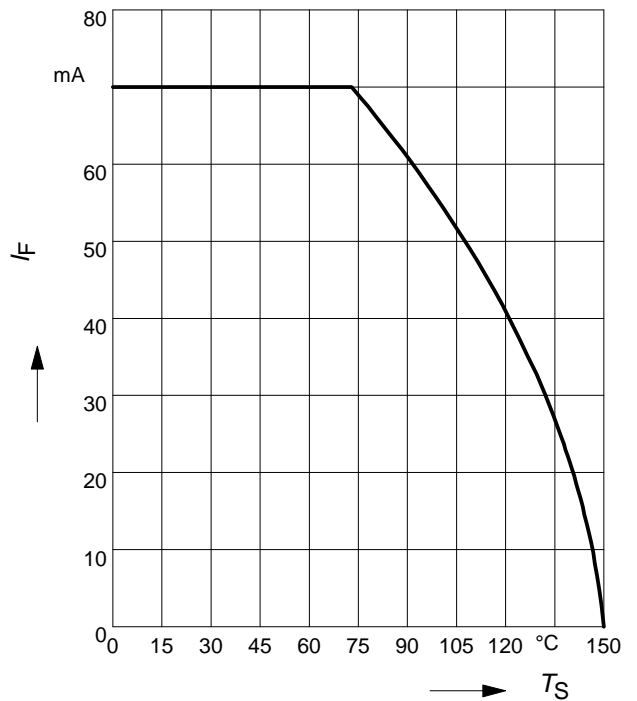

Forward current $I_F = f(T_S)$

BAS70-04, BAS70-06

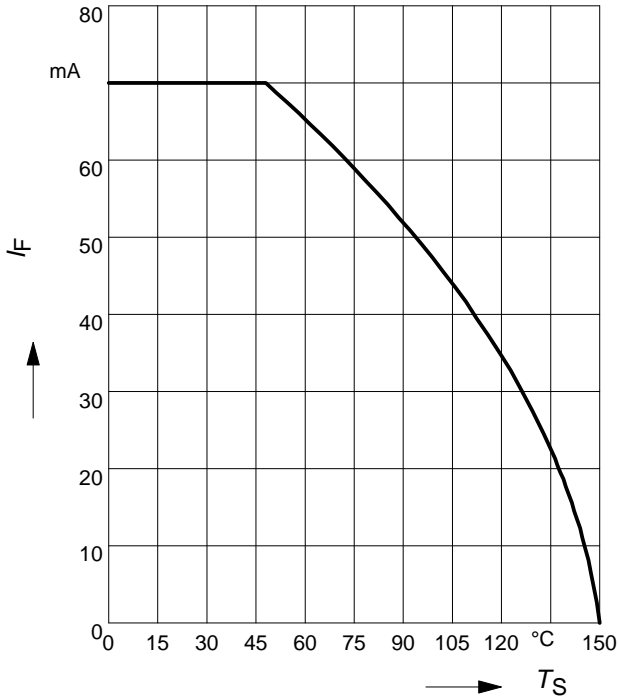

Forward current $I_F = f(T_S)$

BAS70-05

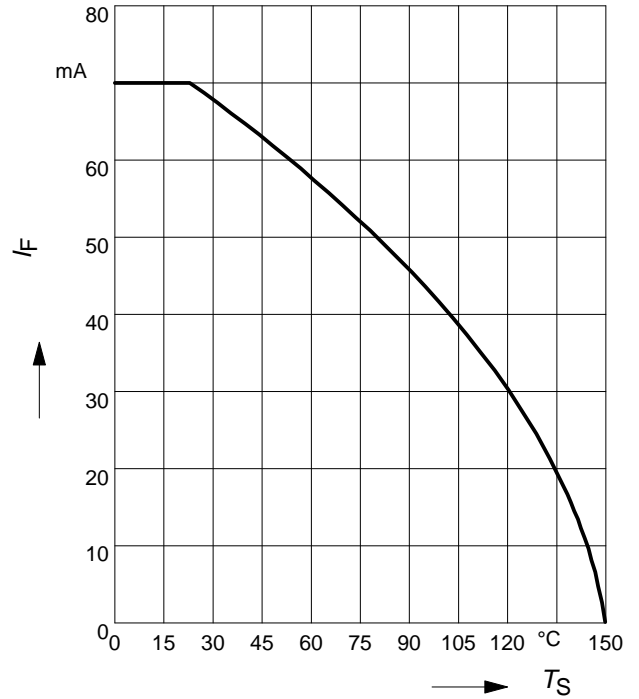

Forward current $I_F = f(V_F)$

$T_A = 25^\circ\text{C}$

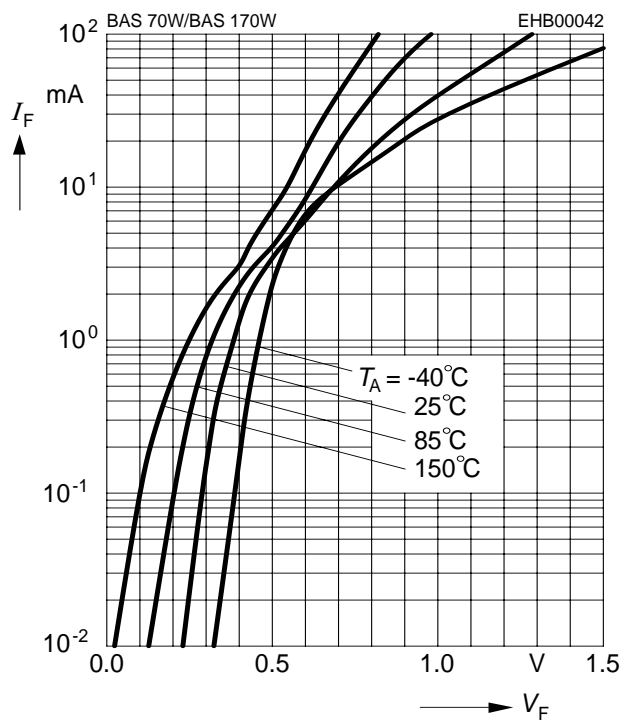

Permissible Pulse Load

$I_{Fmax}/I_{FDC} = f(t_p)$

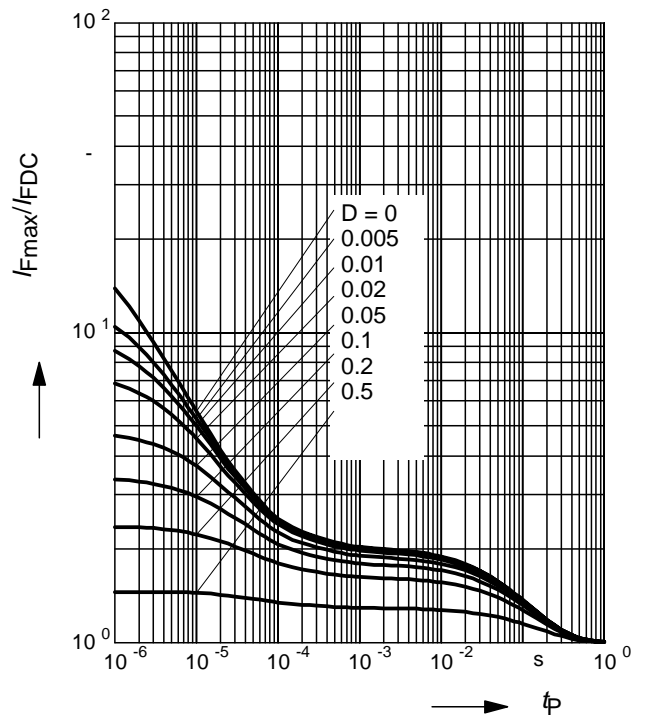

Permissible Puls Load $R_{thJS} = f(t_p)$

